

# Precision TEC Controller as Arduino shield

R.X. 2016 <http://hololaser.kwao.me>

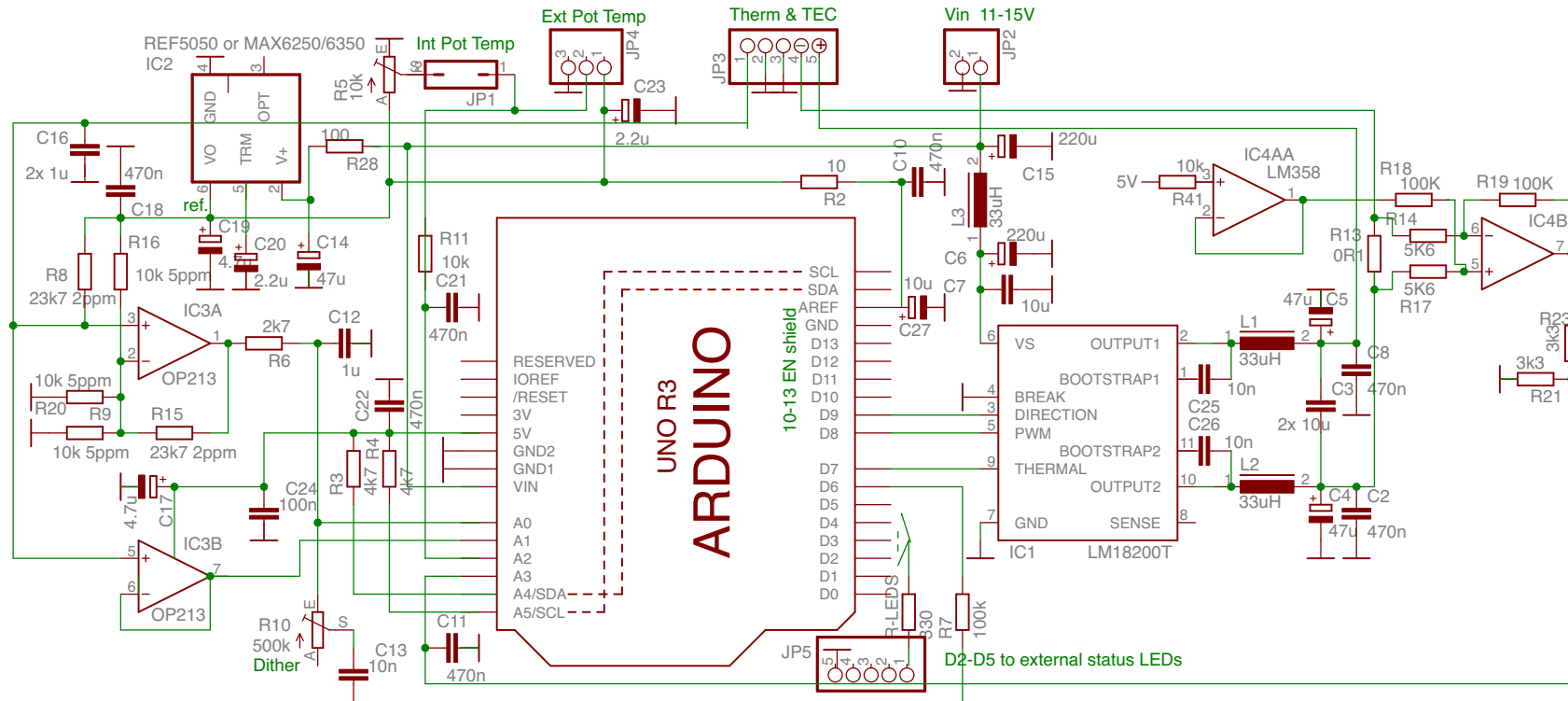

ArduinoTEC, Type LMD18200, Version 2.02 04-2020

Range=15-24C, Therm=10k@25C